

B

VS 10-75 CG OPTIMA
VS 40-150 CG OPTIMA SUP
VS 40-150 CG OPTIMA SUP-EXH

APPLICATION: AS80-S / AS80-R
AS208-S / AS208-R



common ground terminal GND



common terminal 24VAC

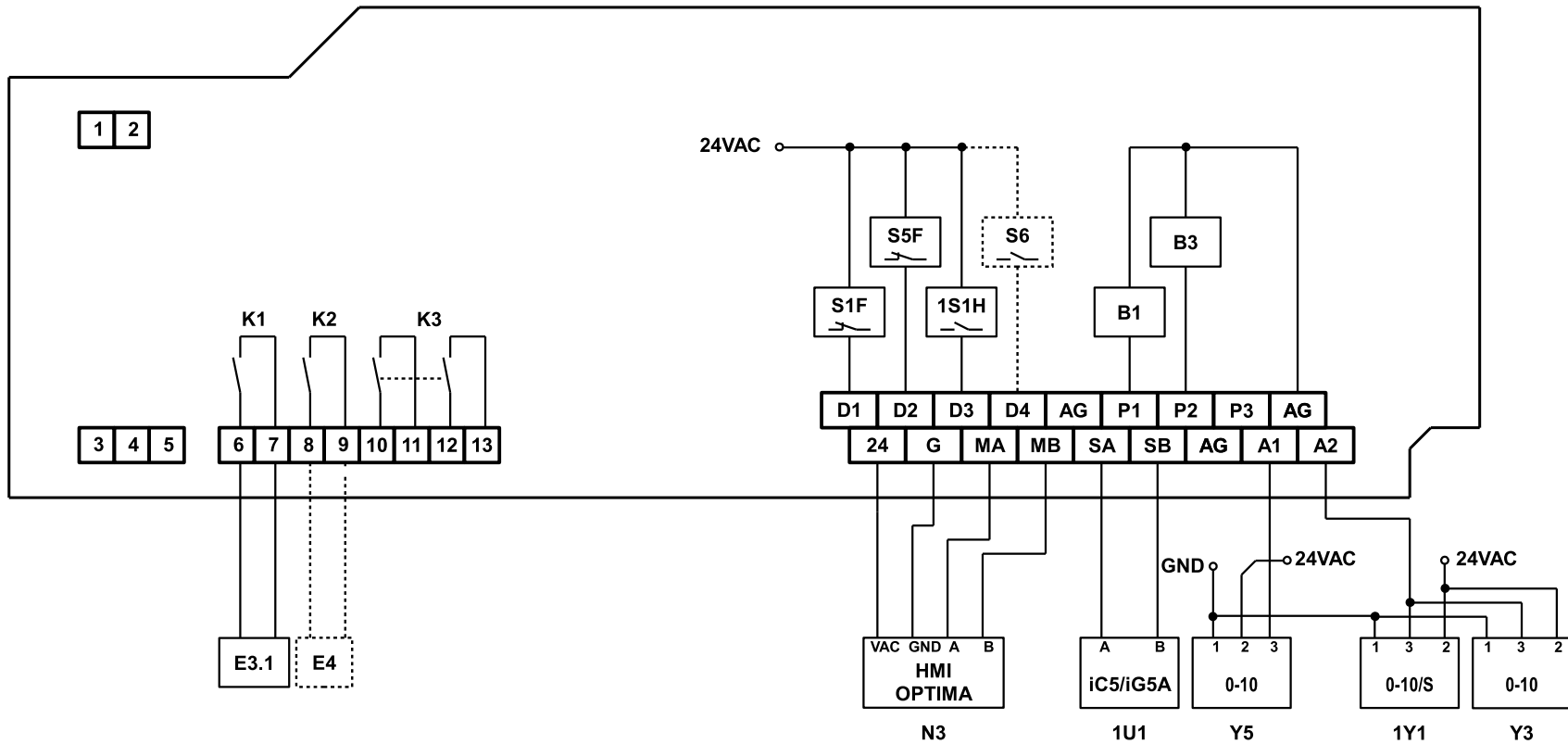

B

VS 10-75 CG OPTIMA
VS 40-150 CG OPTIMA SUP
VS 40-150 CG OPTIMA SUP-EXH

RS485 / Modbus connection details

